



SPXFLOW

NoTap GUIDE

FOR QUICKER AND
EASIER PIPE WORK



Tigerholm Series

TABLE OF CONTENTS

10 good reasons to use NoTap	4
NoTap Advantages	5
What you can do with NoTap	6

BRANCH (T-PIPE) CONNECTION

GENERAL

Branch connection	7
Clamp with check valve	8
Clamp without check valve	9
Tools	10-11

WORK INSTRUCTIONS

Branch connection – clamp with check valve	12-13
Branch connection – clamp without check valve	14-15

DIMENSIONS GUIDE

Straight or angled mini ball valve	17
Optional valve 1/2" or 3/4"	18
Optional ball valve, not for branch connections	19
Ball valve 1"	20
Ball valve 1 1/2"	21
Ball valve 2"	22
Ball valve 2 1/2"	23

ADAPTER FOR IMMERSION PIPE

General info on adapter for immersion pipe	24
Work instruction	25
Dimension guide	26

PIPE BLOCKING

General info on pipe blocking	27
Tools	28
Balloons	29
Work instructions	30-32

DIMENSION GUIDE

Pipe dimensions 14-23 mm	34
Pipe dimensions 26-34 mm	35
Pipe dimensions 35-49 mm	36
Pipe dimensions 50-60.3 mm	37

TOOL KITS

TigerLight	38
TigerTee	39
TigerConnect	40
TigerPro	41

GENERAL INFO

FAQ	42
NoTap hole saw rpm table for branch connections	43
Notes	43

10 good reasons to use NoTap

Do pipe work on pressurized lines quickly and easily with NoTap. Experience some of the many great advantages. Here is a taste of 10 of them.

1. No need to drain the system.
2. No refilling or venting the system after work is completed.
3. Easy installation as no soldering, cutting or welding is necessary.
4. Can be used on all types of metal piping: black steel, painted steel, galvanised, stainless and even copper.
5. Saves energy, as no hot water needs to be drained.
6. Can be used for hot water, fresh water, compressed air and refrigerants (glycol and salt based solutions).
7. Eliminates problems associated with the use of heating equipment, such as welding, soldering, etc.
8. Less corrosion in the system as no fresh, oxygen-rich water is added.
9. Method is environmentally friendly, as no hazardous water needs to be drained.
10. No fragments from drilling operations will enter into the system.

Always follow local installation regulations.

Advantages for the contractor

- The job time is reduced considerably
- Better profitability as more jobs can be carried out within a given time
- Solves problems that are otherwise difficult to manage
- Can offer customers better service and solutions
- No need to handle chemicals when modifying cooling systems

Advantages for the property owner

- Tenants are not disturbed during pipe work
- Tradesmen are able to carry on with their operation despite the pipe work (dentists, hospitals, etc.)
- Lower installation costs
- Work can be carried out during normal business hours eliminating the need for costly weekend or after hour work
- Less corrosion in the water system for increased life expectancy of the system
- Reduced risk for water damages due to faucets left open
- Environmentally friendly



All this can be done with NoTap!

With NoTap you can do repairs and branch connections without first draining the system. You will save a lot of time and money and the method is simple! Below you will see some examples of work that can be done using NoTap.

Installation of new water outlet

You can make simple branch (T-pipe) connections in the kitchen or bathroom for installing, for example, a new washing machine, dishwasher, coffee maker or other household machines. See the chapter on branch connections.

Installing new connections

NoTap allows you to easily connect additional piping to existing heating, water and cooling systems in the building. One example would be connecting a new radiator. See the chapter on branch connections.

Installing and replacing valves and pumps

Are you replacing a valve, pump or mixing valve in a system? Try our method of pipe blocking on each side of the valve or pump first. Then do your replacement with ease. See the chapter on blocking.

Repairing leaks

Do you have a pipe that is leaking? Try our method of blocking on each side of the leak. Then repair the leak quickly and easily. See the chapter on blocking.

Installing heat pumps, boilers and heat exchangers

Use NoTap when you need to rebuild the heating system. The installation will go quicker by using our method of blocking and you will avoid problems with corrosion as no fresh, oxygen-rich water is added to the system. See the chapter on blocking.

Installing gauges etc.

With the NoTap adapter for immersion pipes, a temperature gauge or other measuring device can easily be installed without draining the system. See the chapter on adapter for immersion pipes.

Heating equipment

With NoTap you will totally avoid problems associated with heating equipment such as welding, soldering, etc.

On the following pages you will find everything you need to know about branch (T-pipe) connections



Branch (T-pipe) connections on pressurized water or air pipe systems are done with ease using NoTap. The part that is mounted on the pipe is called a clamp. After the clamp has been tightened to the pipe, a special bore tool is used to allow work to be carried out while the pipe is still under pressure. This eliminates the need to shut off or drain the system.

The NoTap clamp is available in two versions: with or without a check valve. The clamp with a check valve is used for smaller branch connections, installing an immersion pipe adapter and for blocking. The clamp without a check valve is used on branch connections where you want to maintain maximum flow. These clamps come in even larger dimensions than those with check valves.

Clamp with check valve



The clamp with a check valve is used for smaller branch connections, installing an immersion pipe adapter and for blocking. For branch connections, a connector is mounted on the clamp that opens the check valve. For immersion pipes an adapter is mounted, and for blocking a balloon tool is used for inserting the balloon into the pipe. Work instructions are provided on pages 12-13.

Technical data for clamp with check valve

Pipe dimensions: OD 14 mm-125 mm (Cu 15-DN 100)

Branch connection (outlet diameter): DN 20, (OD 14-23) mm or DN 25 (OD 26-125 mm)

Adapter for immersion pipe: OD 26 mm-125 mm (DN 20-DN 100)

Pipe blocking: OD 14 mm-60.3 mm (Cu 15-DN 50)

Flow diameter: Ø 8.4 mm (OD 14-23 mm) or 14.4 mm (OD 26-125 mm)

Max. system pressure: 16 bar / 6 bar (pipe dimension DN 65 and larger)

Max. temperature: +95°C

Min. temperature: -10°C

Type of pipes: All pipes of metal, for example: black, painted, galvanised, stainless as well as copper. Valid for both thin-walled and annealed tempered pipe.

Media: hot water, fresh (tap) water, compressed air and refrigerants (glycol and salt based solutions). For other applications, contact us.

Clamp without check valve



The clamp without a check valve is used when larger branch dimensions are desired for maximum flow from the branch connection. A full-flow ball valve shall always be fitted on these clamps when work is to be carried out on pressurized pipes. Work instructions are explained on pages 14-15.

Technical data for clamp without check valve

Pipe dimensions: OD 26-335 mm (DN 20-DN 300)

Branch connection (outlet diameter): DN 25, DN 40, DN 50 or DN 65

Flow diameter: Ø 19-57 mm

Max. system pressure: 16 bar / 10 bar (pipe dimension DN 150 and larger)

Max temperature: +95°C

Min. temperature: -10°C

Type of pipes: All pipes of metal, for example: black, painted, galvanised, stainless as well as copper. Clamps with 1½", 2" and 2½" connections must **not** be used on annealed copper pipes.

Media: hot water, fresh (tap) water, compressed air and refrigerants (glycol and salt based solutions). For other applications, contact us.

Tools and parts description

The NoTap system consists of a number of tools and parts that you will easily learn to use. Here you will find the parts with our article numbers (within parentheses).

Tools for clamps with check valve



Drill 8.4 mm
(110 070)



Drill housing 8.4 mm
(110 000)



Drill 14.4 mm
(110 270)



Drill housing 14.4 mm
(110 200)

Adapters



Adapter 8.4 mm
(111 000)



Adapter 14.4 mm
(111 000)



Lubricant
(112 650-02)

Tools for clamp without check valve for 1" ball valve



Drill housing 1"
(120 000)



Hole saw 19 mm
(120 160)



Hole saw 24 mm
(120 130)



Centre bit
(120 110)



Hole saw holder 1"
(120 120)

Tools for clamp without check valve for 1½", 2" and 2½" ball valves



Hole saw 1½"
(121 010)



Drill housing 1½"
(120 400)



Hole saw 2"
(121 020)



Drill housing 2"
(120 500)



Hole saw 2½"
(121 030)



Drill housing 2½"
(120 650)



Centre bit
(120 150)



Hole saw holder (120
830)



19 mm socket
(125 160)



22 mm socket
(125 170)

Pressure testing nippel
(125 150)



Torque wrench
(125 100)

This is how simple branch connections are on clamps with check valves.

This same method is used for pipe blocking and mounting an immersion pipe adapter. Always use an outlet with earth fault breaker.



1. Apply clamp and adapter

- Clean pipe thoroughly where the clamp seal is to be placed.
- Install a clamp with check valve in correct dimension. Screw on adapter.

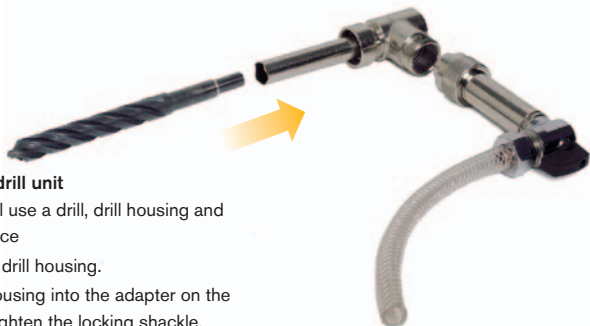

2. Assemble drill unit

Here you will use a drill, drill housing and flushing device

- Insert drill in drill housing.
- Insert drill housing into the adapter on the clamp and tighten the locking shackle. Tighten the flushing device to the drill housing.
- Insert the small diameter portion of the drill into the drill chuck. See that the bevelled edge of the drill is at the end of the chuck. This prevents from drilling through the backside of the pipe.

3. Drilling the hole

- Be sure the valve on the flushing device is open and drill the hole.
- Water will begin to flow when the drill penetrates the pipe. Adjust the flow with the valve.
- Continue drilling until the drill chuck meets the drill housing.

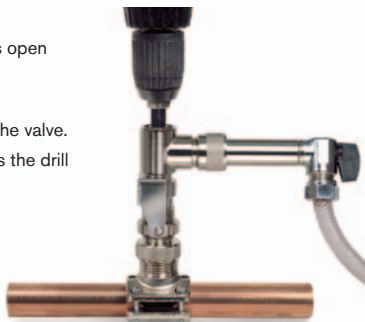

4. Pulling out the drill

- Stop drilling and pull back the drill completely.
- Loosen the shackle on the adapter and put aside.
- Carefully begin to pull the drill housing out of the adapter.
- When the drill housing is removed halfway, the check valve closes stopping the flow of water in the hose. If the flow of water does not stop, push the drill housing in again to clean away burrs from the check valve.



5. Disassemble the drilling unit

- Loosen the drill chuck, remove the drill and then remove the flushing device.
- Empty the flushing device of burrs that have collected in the filter.
- Remove the adapter and mount the desired connector.

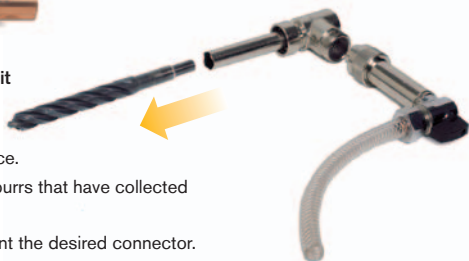

This is how simple branch connections are on clamps without check valves.

Always use an outlet with earth fault breaker.

1. Apply clamp and ball valve

- Clean pipe thoroughly where the clamp seal is to be placed.
- Install clamp in the correct dimension and wind with ong-fibre and jointing compound.
- Thread tight a full-flow ball valve and leave it in the open position.

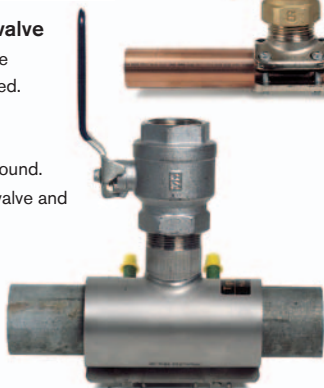
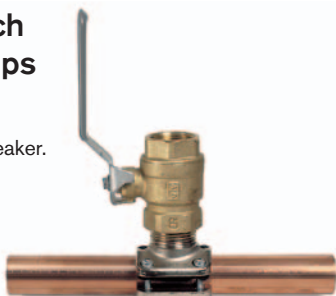

2. Assemble drilling unit

Here you will use a centre bit, hole saw holder, hole saw, drill housing and flushing device.

- Insert the centre bit into the hole saw holder so that the screw will tighten against the flat portion.
- Thread the hole saw to the hole saw holder and then insert into drill housing.
- Tighten the drill housing to the ball valve and attach the flushing device.
- Insert drill shank so that the centre bit is touching the pipe. Tighten drill chuck to the drill shank.

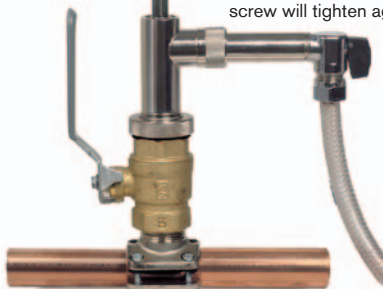

3. Drilling

- Drill with low rotation speed (approx. 200 rpm) and steady pressure.
- A flow will start when the centre bit penetrates the pipe. Adjust the flow with the valve.
- Drill until hole saw has penetrated the pipe.

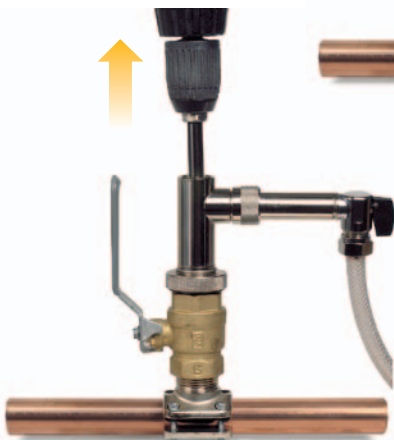
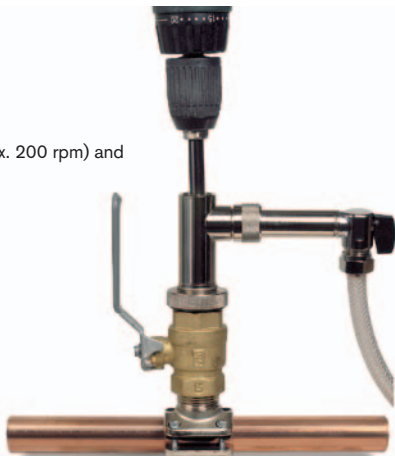

4. Pulling out the drill

- Stop drilling when the hole saw has penetrated the pipe and pull out the drill shank completely.
- Close the ball valve.

5. Disassemble the drilling unit

- Remove drill and flushing device. Then remove drill housing.
- Loosen the centre bit and remove centre bit and the piece of pipe. Tighten centre bit in place again.
- Empty the flushing device of burrs that have collected in the filter.

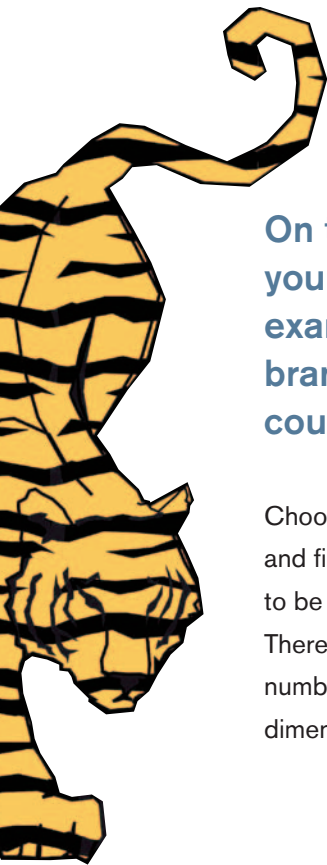

On the following pages you will find different examples of what your branch connections could look like.

Choose the type of branch connection and find the correct dimension of pipe to be drilled in the appropriate tables. There you will easily see the article numbers for the clamps in each pipe dimension.

Straight or angled mini ball valve

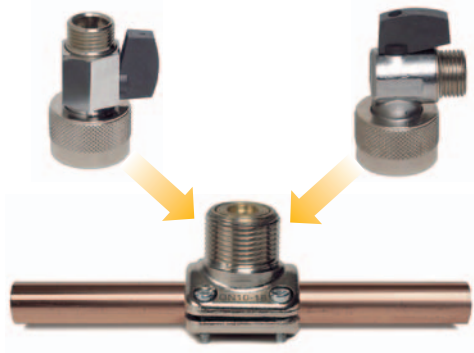

Fits on pipes with diameter 14 – 125 mm

For work instruction, see pages 12-13.

Clamp with check valve

Always used when pipe blocking (14-60,3 mm) and even for smaller branch connections. For branch connections, use one of our connectors which have a collar that opens the check valve.

Pipe diameter (OD)	Clamp art no.	Straight valve art no.	Angled valve art no.	Drill diameter
14-17 mm (Cu 15)	1401016E-02	137400E-02	137800E-02	8.4 mm
17-19 mm (DN 10/Cu 18)	1401018E-02	137400E-02	137800E-02	8.4 mm
21-23 mm (DN 15/Cu 22)	1401022E-02	137400E-02	137800E-02	8.4 mm
26-32 mm (DN 20/Cu 28)	1401028E-02	137500E-02	137900E-02	14.4 mm
33-38 mm (DN 25/Cu 35)	1401035E-02	137500E-02	137900E-02	14.4 mm
39-45 mm (DN 32/Cu 42)	1401042E-02	137500E-02	137900E-02	14.4 mm
46-49 mm (DN 40)	1401048E-02	137500E-02	137900E-02	14.4 mm
50-52 mm	1402051E-02	137500E-02	137900E-02	14.4 mm
53-58 mm (Cu 54)	1402054E-02	137500E-02	137900E-02	14.4 mm
55-65 mm (DN 50)	1402060E-02	137500E-02	137900E-02	14.4 mm
74-83 mm (DN 65/Cu 76.1)	1402076E-02	137500E-02	137900E-02	14.4 mm
85-98 mm (DN 80/Cu 88.9)	1402089E-02	137500E-02	137900E-02	14.4 mm
108-125 mm (DN 100)	1402114E-02	137500E-02	137900E-02	14.4 mm

Optional valve with 1/2" or 3/4" pipe thread

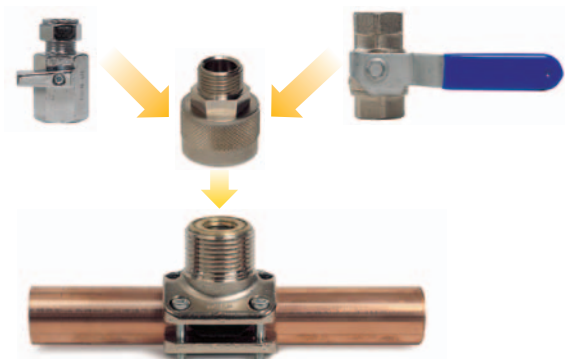

Fits on pipes with diameter 14 – 125 mm

For work instruction, see pages 12-13.

Clamp with check valve

Always used when pipe blocking (14-60,3 mm) and even for smaller branch connections. For branch connections, use one of our connectors which have a collar that opens the check valve.

Pipe diameter (OD)	Clamp art no.	Connection with 1/2" pipe thread art no.	Connection with 3/4" pipe thread art no.	Drill diameter
14-17 mm. (Cu 15)	1401016E-02	137200E-02		8.4 mm
17-19 mm (DN 10/Cu 18)	1401018E-02	137200E-02		8.4 mm
21-23 mm (DN 15/Cu 22)	1401022E-02	137200E-02		8.4 mm
26-32 mm (DN 20/Cu 28)	1401028E-02	137300E-02	137350E-02	14.4 mm
33-38 mm (DN 25/Cu 35)	1401035E-02	137300E-02	137350E-02	14.4 mm
39-45 mm (DN 32/Cu 42)	1401042E-02	137300E-02	137350E-02	14.4 mm
46-49 mm (DN 40)	1401048E-02	137300E-02	137350E-02	14.4 mm
50-52 mm	1402051E-02	137300E-02	137350E-02	14.4 mm
53-58 mm (Cu 54)	1402054E-02	137300E-02	137350E-02	14.4 mm
55-65 mm (DN 50)	1402060E-02	137300E-02	137350E-02	14.4 mm
74-83 mm (DN 65/Cu 76.1)	1402076E-02	137300E-02	137350E-02	14.4 mm
85-98 mm (DN 80/Cu 88.9)	1402089E-02	137300E-02	137350E-02	14.4 mm
108-125 mm (DN 100)	1402114E-02	137300E-02	137350E-02	14.4 mm

Optional ball valve not connected to the branch connection

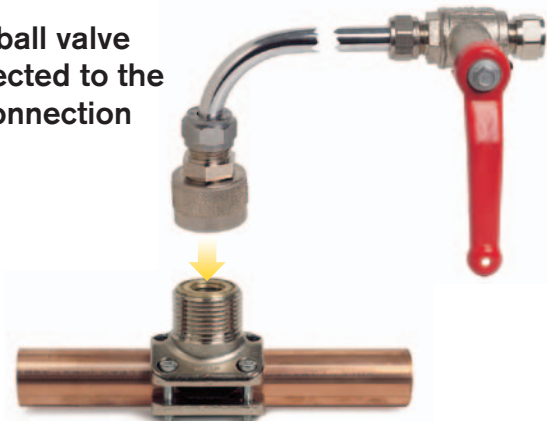

Fits on pipes with diameter 14 – 125 mm

For work instruction, see pages 12-13.

Clamp with check valve

Always used when pipe blocking (14-60,3 mm) and even for smaller branch connections. For branch connections, use one of our connectors which have a collar that opens the check valve.

Pipe diameter (OD)	Clamp art no.	Connection with 1/2" pipe thread art no	Connection with 3/4" pipe thread art no.	Drill diameter
14-17 mm. (Cu 15)	1401016E-02	137200E-02		8.4 mm
17-19 mm (DN 10/Cu 18)	1401018E-02	137200E-02		8.4 mm
21-23 mm (DN 15/Cu 22)	1401022E-02	137200E-02		8.4 mm
26-32 mm (DN 20/Cu 28)	1401028E-02	137300E-02	137350E-02	14.4 mm
33-38 mm (DN 25/Cu 35)	1401035E-02	137300E-02	137350E-02	14.4 mm
39-45 mm (DN 32/Cu 42)	1401042E-02	137300E-02	137350E-02	14.4 mm
46-49 mm (DN 40)	1401048E-02	137300E-02	137350E-02	14.4 mm
50-52 mm	1402051E-02	137300E-02	137350E-02	14.4 mm
53-58 mm (Cu 54)	1402054E-02	137300E-02	137350E-02	14.4 mm
55-65 mm (DN 50)	1402060E-02	137300E-02	137350E-02	14.4 mm
74-83 mm (DN 65/Cu 76.1)	1402076E-02	137300E-02	137350E-02	14.4 mm
85-98 mm (DN 80/Cu 88.9)	1402089E-02	137300E-02	137350E-02	14.4 mm
108-125 mm (DN 100)	1402114E-02	137300E-02	137350E-02	14.4 mm

Ball valve 1"

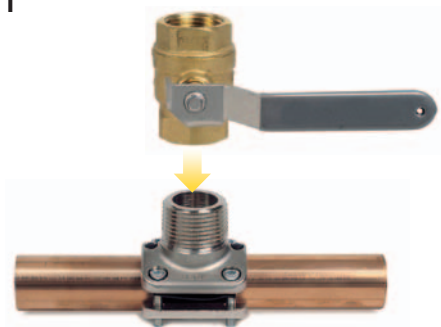

Fits on pipes with diameter 26 – 170 mm

For work instruction, see pages 14-15.

Clamp without check valve

Pipe diameter (OD)	Clamp art no.	Hole saw diameter
26-32 mm (DN 20/Cu28)	1403028E-02	19 mm
33-38 mm (DN 25/Cu35)	1403035E-02	19 mm
39-45 mm (DN 32/Cu42)	1403042E-02	24 mm
46-49 mm (DN 40)	1403048E-02	24 mm
50-52 mm	1404051E-02	24 mm
53-58 mm (Cu 54)	1404054E-05	24 mm
55-65 mm (DN 50)	1404060E-05	24 mm
61-75 mm (Cu 70)	1404068E-05	24 mm
74-83 mm (DN 65/Cu 76.1)	1404076E-05	24 mm
77-88 mm	1404083E-05	24 mm
85-98 mm (DN 80/Cu 88.9)	1404089E-05	24 mm
94-111 mm (Cu 100)	1404102E-05	24 mm
108-125 mm (DN 100/Cu 108)	1404114E-05	24 mm
122-138 mm (Cu 133)	1404129E-05	24 mm
136-152 mm (DN 125)	1404140E-05	24 mm
145-160 mm (Cu 159)	1404152E-05	24 mm
158-170 mm (DN 150)	1404168E-05	24 mm

Ball valve 1 1/2"

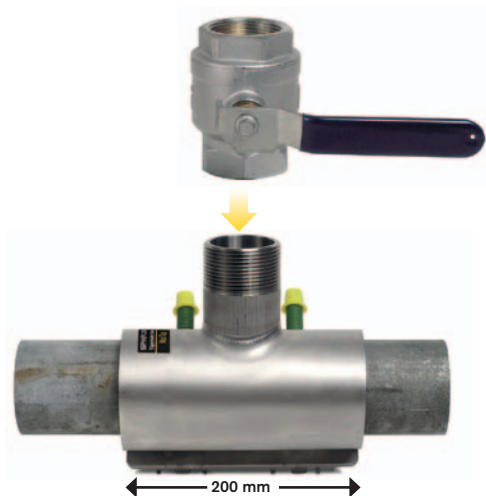

Fits on pipes with diameter 54 – 165 mm

For work instruction, see pages 14-15.

Clamp without check valve

Delivered with Ball valve with both low and high spindle.

Pipe diameter (OD)	Clamp art no.	Hole saw diameter
54-58 mm (Cu 54)	147054E-01	35 mm
60-67 mm (DN 50)	147060E-01	35 mm
63-70 mm (Cu 70)	147063E-01	35 mm
75-82 mm (DN 65/Cu 76.1)	147065E-01	35 mm
82-89 mm (DN 80/Cu 88.9)	147070E-01	35 mm
88-95 mm (DN 80/Cu 88.9)	147080E-01	35 mm
112-135 mm (DN 100)	147099E-01	35 mm
145-165 mm (Cu 159)	147130E-01	35 mm

Ball valve 2"

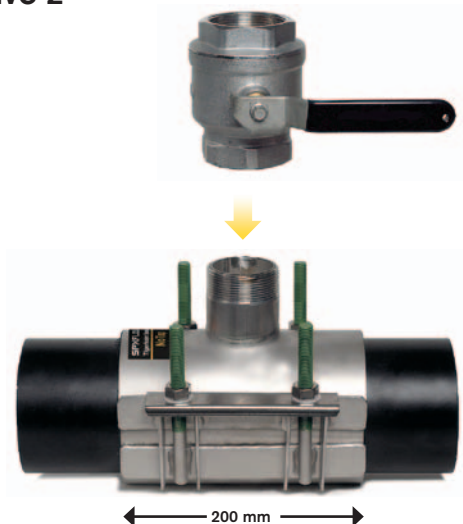

Fits on pipes with diameter 70 – 134 mm

For work instruction, see pages 14-15.

Clamp without check valve

Delivered with Ball valve with both low and high spindle.

Pipe diameter (OD)	Clamp art no.	Hole saw diameter
70-77 mm (Cu 70)	147064E-01	45 mm
75-82 mm (DN 65/Cu 76.1)	147066E-01	45 mm
82-89 mm (DN 80/Cu 88.9)	147071E-01	45 mm
88-95 mm (DN 80/Cu 88.9)	147081E-01	45 mm
95-102 mm (Cu 100)	147085E-01	45 mm
102-112 mm (Cu 108)	147090E-01	45 mm
112-134 mm (DN 100)	147100E-01	45 mm

Ball valve 2 1/2"

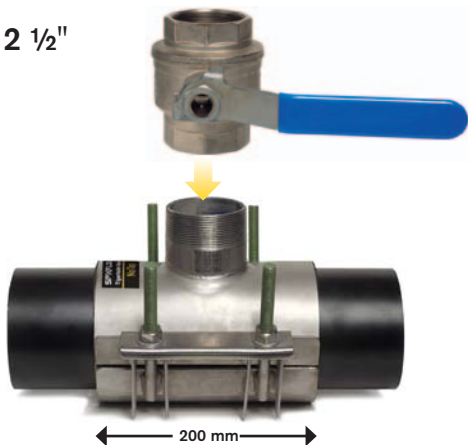

Fits on pipes with diameter 88 – 335 mm

For work instruction, see pages 14-15.

Clamp without check valve

Delivered with Ball valve with both low and high spindle.

Pipe diameter (OD)	Clamp art no.	Hole saw diameter
88-95 mm (DN 80/Cu 88.9)	147082E-01	57 mm
95-102 mm (Cu 100)	147086E-01	57 mm
102-112 mm (Cu 108)	147091E-01	57 mm
112-134 mm (DN 100)	147101E-01	57 mm
133-155 mm (DN 125/Cu 133)	147125E-01	57 mm
145-165 mm (Cu 159)	147132E-01	57 mm
168-188 mm (DN 150)	147150E-01	57 mm
190-210 mm	147170E-01	57 mm
215-235 mm (DN 200)	147200E-01	57 mm
251-271 mm	147225E-01	57 mm
272-292 mm (DN 250)	147250E-01	57 mm
292-315 mm	147270E-01	57 mm
315-335 mm (DN 300)	147300E-01	57 mm

General information about the immersion pipe adapter



The immersion pipe adapter allows you to fit a thermometer or other measuring device on pressurised pipes. The system does not need to be shut down or drained. The immersion pipe adapter is fitted to a clamp with a check valve and then the measuring device is inserted into the pipe.

The immersion pipe adapter is suitable for thermometers with \varnothing 8.5 mm and 10 mm respectively. Two alternative gaskets (seals) are included that seal to the clamp. The measuring device should be sealed to the clamp.

This is how simple it is to fit a thermometer

- 1. Mount a clamp with check valve to the pipe and drill the hole.**
Follow instructions for mounting clamp and drilling on pages 12-13.
- 2. Mount an immersion pipe adapter**
Use the appropriate gasket (seal) at the bottom of the adapter and thread the adapter tight to the clamp.
- 3. Mount the thermometer**
Use a thread seal adhesive on the thermometer threading.
Press down the thermometer into the adapter and thread tight.



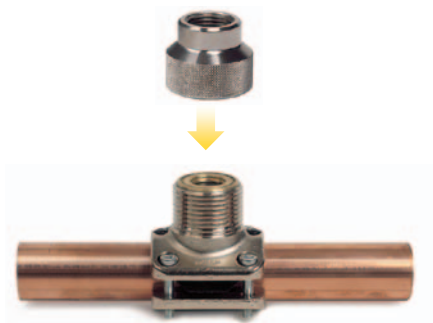

Can be mounted on pipes with diameter 26 - 125 mm

Thermometer with length of 63 mm is suitable for pipes DN20 – DN100.

Thermometer with length of 100 mm is suitable for pipes DN65 – DN100.

For work instruction, see pages 12-13 and 25.

Clamp with check valve

Pipe diameter (OD)	Clamp art no.	Immersion pipe adapter art no.	Drill diameter
26-32 mm (DN 20/Cu 28)	1401028E-02	135850E-02	14.4 mm
33-38 mm (DN 25/Cu 35)	1401035E-02	135850E-02	14.4 mm
39-45 mm (DN 32/Cu 42)	1401042E-02	135850E-02	14.4 mm
46-49 mm (DN 40)	1401048E-02	135850E-02	14.4 mm
50-52 mm	1402051E-02	135850E-02	14.4 mm
53-58 mm (Cu 54)	1402054E-02	135850E-02	14.4 mm
55-65 mm (DN 50)	1402060E-02	135850E-02	14.4 mm
74-83 mm (DN 65/Cu 76.1)	1402076E-02	135850E-02	14.4 mm
85-98 mm (DN 80/Cu 88.9)	1402089E-02	135850E-02	14.4 mm
108-125 mm (DN 100)	1402114E-02	135850E-02	14.4 mm

On the following pages you will find everything you need to know about pipe blocking



Blocking is done by inserting a balloon into a pipe and blowing it up. In order to insert the balloon, a clamp must be mounted and a hole must be drilled into the pipe. The balloons come in four sizes, suited for different pipe dimension. The balloons and tooling are colour coded to help select correct dimensions. When the work is done, the balloon is removed and a sealed cap is mounted to the clamp.

List of tools

Our article number in parentheses



Support tube 10-1, grey
(113 010)



Support tube
housing
(113 401)



Balloon holder 10
(112 000)



Support tube 16-1, White
(113 210)



Support tube 16-2, Black
(113 220)



Support tube 16-3, Yellow
(113 230)

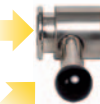

Support tube
housing
(113 401)



Balloon holder 16
(112 200)



Lubricant
(112 650-02)



Hexagon screwdriver
2.5 mm (112 640)
4.0 mm (112 630)



Hand pump
(112 500)

Balloons



Technical data, Balloons

Media: hot water, fresh (tap) water, compressed air and refrigerants (glycol and salt based solutions). For other applications, contact us.

Ballon type	10-1	16-1	16-2	16-3
Plug color:	Grey	White	Black	Yellow
Pipe dims, Copper:	15,18, 22	28	35/36,42	54
Pipe dims, Steel:	DN10,15	DN20,25	DN32,40	DN50
Support tube:	10-1 grey	16-1 white	16-2 black	16-3 yellow
Max system pressure:	5 bar	5 bar	5 bar	3 bar
Min-Max system temperature:	10°-50°C	10°-50°C	10°-50°C	15°-40°C
Max blocking time at 30°C:	4 hours	4 hours	4 hours	1 hours
Max blocking time at 40°C:	2 hours	2 hours	2 hours	1 hour
Max blocking time at 50°C:	1 hour	1 hour	1 hour	–
Art no.	138300E-02	138310E-02	138320E-02	138330E-02

This is how simple it is to block a pipe using the NoTap method

First make a branch connection using a clamp with a check valve according to instructions on pages 12-13. Leave the adapter in place.



1. Mounting support tube to support tube housing

- Choose support tube according to colour marking system. Colours are indicated on package labels of clamps and balloons.
- Unscrew the locking screw and pull out the stop ball on the support tube housing. Insert the support tube completely and release the stop ball. Twist until it locks into position. Tighten locking screw.



2. Measuring system pressure

- Insert the balloon holder (without balloon) into the support tube.
- Insert the blocking device through the adapter into the drilled pipe hole.
- Read system pressure from the pressure gauge.



3. Mounting the balloon and assembling the blocking device

- Unscrew the blocking plug on the balloon holder. Insert the hexagon screwdriver until it comes out through the nipple. Unscrew the nipple until a couple of threads can be seen.
- Push the balloon onto the balloon nipple. Screw the nipple counter clockwise until it comes to a distinct stop.
- Lubricate the balloon and the inside of the support tube generously with NoTap lubricant.
- While holding the stop ball open, insert the balloon into the support tube. Press the hexagon screwdriver making the balloon oval shaped for easier insertion. Tip, Hold the support tube against the floor between your feet and push on the hexagon screwdriver.
- Push the grey balloon only halfway into the support tube. White, black and yellow balloons are pushed in until the stop ball locks at the first position.
- Important! Remove the screwdriver from the balloon holder and screw tight the blocking plug before the balloon is inserted into the system.

4. Inserting the balloon into the pipe

- Point the stop ball toward where the pipe is to be cut. Then push the blocking device into the adapter on the clamp. Mount locking shackle.
- Place your hand over the balloon holder, pull out the stop ball and press down until the stop ball locks at the final position. The balloon is now in the pipe.
- Connect the air pump to the valve and pump up to 10 bar over system pressure. Wait one minute and reduce to 5 bar over system pressure by using the nipple attached to the air hose. The pipe is now blocked.



5. Disassembly

- When work is completed, let air out of balloon by loosening the blocking plug.
- Loosen the adapter shackle. Grip under stop ball and forcefully pull out entire blocking device (without twisting). The check valve will automatically close.
- Unscrew the adapter. Mount the cap, which is included with the balloon kit. The balloon is for one-time use only and should be cut away with cutting nippers. Remove balloon holder and disassemble the parts.

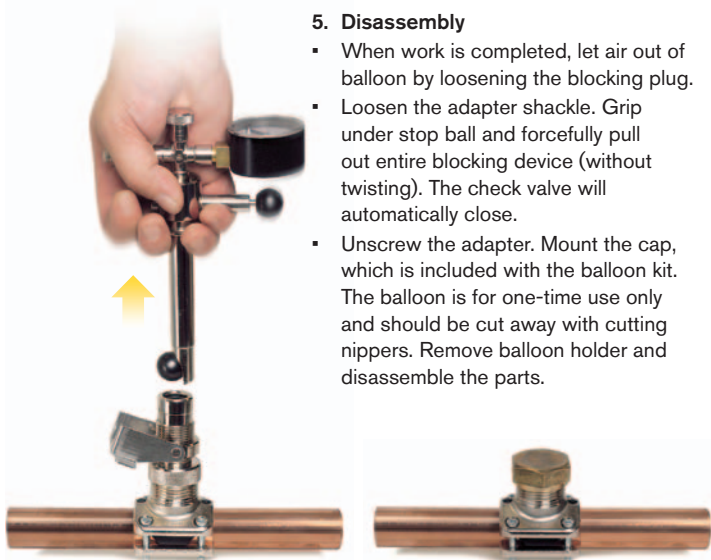

**On the following pages
you will find blocking
kits needed for
different pipe
dimensions.**

Use the heading for the correct dimension interval of pipe to be blocked. Go down to the list and find the exact dimension and article description that is needed for the blocking.

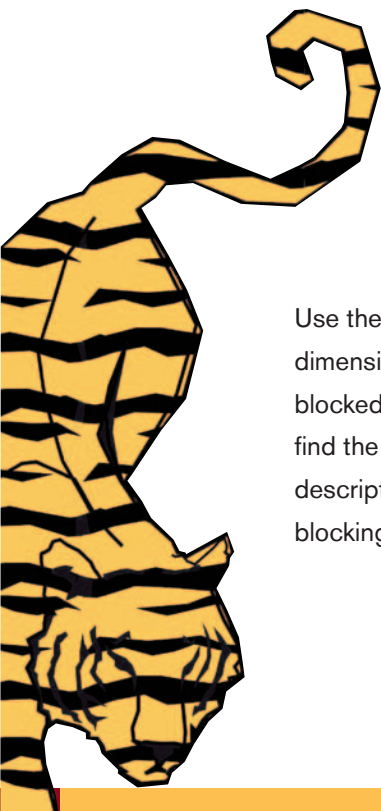

Pipe dimensions 14-23 mm



For work instructions, see pages 30-32.

Colour code for these parts: Grey

Clamp with check valve

Always used when pipe blocking and even for smaller branch connections. For branch connections, use one of our connectors which have a collar that opens the check valve.

Max system pressure 5 bar, Max system temperature 50°C

Pipe diameter (OD)	Clamp art no.	Ballonn kit art no.	Drill diameter
14-17 mm, (Cu 15)	1401016E-02	138300E-02	8.4 mm
17-19 mm, (DN 10/Cu 18)	1401018E-02	138300E-02	8.4 mm
21-23 mm, (DN 15/Cu 22)	1401022E-02	138300E-02	8.4 mm

Pipe dimensions 26-34 mm

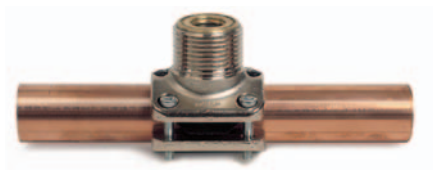

For work instructions, see pages 30-32.

Colour code for these parts: White

Clamp with check valve

Always used when pipe blocking and even for smaller branch connections. For branch connections, use one of our connectors which have a collar that opens the check valve.

Max system pressure 5 bar, Max system temperature 50°C

Pipe diameter (OD)	Clamp art no.	Ballonn kit art no.	Drill diameter
26-32 mm, (DN 20/Cu 28)	1401028E-02	138310E-02	14.4 mm
33-34 mm, (DN 25)	1401035E-02	138310E-02	14.4 mm

Pipe dimensions 35-49 mm



For work instructions, see pages 30-32.

Colour code for these parts: Black

Clamp with check valve

Always used when pipe blocking and even for smaller branch connections. For branch connections, use one of our connectors which have a collar that opens the check valve.

Max system pressure 5 bar, Max system temperature 50°C

Pipe diameter (OD)	Clamp art no.	Ballonn kit art no.	Drill diameter
35-38 mm, (Cu 35)	1401035E-02	138320E-02	14.4 mm
39-45 mm, (DN 32/Cu 42)	1401042E-02	138320E-02	14.4 mm
46-49 mm, (DN 40)	1401048E-02	138320E-02	14.4 mm

Pipe dimensions 50-60.3 mm



For work instructions, see pages 30-32.

Colour code for these parts: Yellow

Clamp with check valve

Always used when pipe blocking and even for smaller branch connections. For branch connections, use one of our connectors which have a collar that opens the check valve.

Max system pressure 3 bar, Max system temperature 40°C

Pipe diameter (OD)	Clamp art no.	Ballonn kit art no.	Drill diameter
50-52 mm	1402051E-02	138330E-02	14.4 mm
53-58 mm (Cu 54)	1402054E-02	138330E-02	14.4 mm
55-60.3 mm (DN 50)	1402060E-02	138330E-02	14.4 mm

TigerLight

TigerLight is our “starter” toolkit for smaller branch connections. With this toolkit you can drill on the pipe dimensions below.



TigerLight branch connection	Pipe diameter (OD)	Clamp outlet diameter
Clamp without check valve	26-170 mm (DN 20-DN 150)	DN 25

Art no. 120000E-05

Parts can be purchased separately

TigerTee

TigerTee is a toolkit for smaller branch connections. With this toolkit you can drill on the pipe dimensions below.



TigerTee branch connection	Pipe diameter (OD)	Clamp outlet diameter
Clamp with check valve	14-125 mm (Cu15-DN100)	DN20, DN25
Clamp without check valve	26-170 mm (DN 20-DN 150)	DN 25
Art no. 115400E-TEE		

Parts can be purchased separately

TigerConnect

TigerConnect is a toolkit for branch connections. With this toolkit you can drill on the pipe dimensions below.



TigerConnect branch connection	Pipe diameter (OD)	Clamp outlet diameter
Clamp without check valve	26-335 mm (DN 20-DN 300)	DN 25, DN 40, DN 50, DN 65
Art no. 1153000E		

Parts can be purchased separately

TigerPro

TigerPro is a toolkit for pipe blocking and smaller branch connections. With this toolkit you can make pipe blockings and do branch (T-pipe) connections on the pipe dimensions below.



TigerPro branch connection	Pipe diameter (OD)	Clamp outlet diameter
Clamp with check valve	14-125 mm (Cu 15-DN 100)	DN 20, DN 25
Clamp without check valve	26-170 mm (DN 20-DN 150)	DN 25
TigerPro Blocking		
Clamp with check valve	14-60.3 mm (Cu 15-DN 50)	DN 20, DN 25
Art no. 115000E-PRO		

Parts can be purchased separately

Common Questions:

Where can I find NoTap tools?

NoTap tools are sold at your HVAC wholesaler. Many wholesalers have tools for rent as well.

Can NoTap be used on all types of pipes?

Yes, NoTap can be used on all pipes of steel, for example, mild steel, painted steel, galvanised steel, stainless steel and copper. Clamps with 1½", 2" and 2½" connections must **not** be used on annealed copper pipes.

How long will the seals hold?

The seals are made of EPDM rubber and should hold at least 50 years. EPDM rubber is also regularly used on o-rings in press couplings.

Is NoTap applicable for both hot and cold?

Yes, the seals manage temperatures from -10°C to +95°C.

Do the seals tolerate refrigerants?

Yes, the seals tolerate among other things, glycol and salt-based solutions. For other applications, contact us for information.

Can NoTap be used on compressed air?

Yes, NoTap works perfectly with compressed air.

Can you drill in systems with no pressure?

Yes, the clamps are so easy and quick to work with that many installers use them also on systems that are not pressurized, for example on hard to reach places or when exact outlets are necessary.

Does NoTap cover all dimensions?

Yes, because each clamp has a span of several mm, NoTap covers a very wide range of pipe dimensions. For example, NoTap can be used even on many of the old pipe dimensions.

Does the clamp tighten against a pipe with a rough surface?

Yes, the clamps will tighten even, for example, on an old galvanised steel pipe. Simply follow the installation instructions contained in the clamp packaging.

NoTap RPM table for branch connection

Hole saw Dim	Pipe Material			
	Stainless	Cast Iron	Steel	Copper
Ø19 mm	230 rpm	300 rpm	460 rpm	600 rpm
Ø24 mm	185 rpm	245 rpm	370 rpm	495 rpm
Ø35 mm	125 rpm	165 rpm	250 rpm	330 rpm
Ø45 mm	95 rpm	130 rpm	195 rpm	255 rpm
Ø57 mm	75 rpm	100 rpm	150 rpm	200 rpm

Notes



SPX Flow Technology Sweden AB

Ever since the Tigerholm brand was founded in 1971, we have had the approach that any problem can be solved with a little thought and ingenuity. Today SPX Flow Technology Sweden is stronger than ever. Our strength lies in a number of unique, patented products that are global leaders in their areas of specialty. We also offer a complete range of products for oil heating systems, thanks to our collaboration with several of Europe's leading manufacturers.

Our expertise in product development together with our product range means we will continue offering our customers high quality innovative products for heating and pipe systems. And, we can do this while offering a safe, efficient, and cost effective installation with reduced impact on the environment.

SPXFLOW

Your local contact:

SPX Flow Technology Sweden AB
Bryggavägen 113
SE-178 31 Ekerö, SWEDEN
Phone: +46 8-560 340 30. Fax: +46 8-560 342 60
E-mail: tigerholm@spxflow.com
www.tigerholm.com
www.spxflow.com

For more information about our worldwide locations, approvals, certifications, and local representatives, please visit www.tigerholm.com.

SPX FLOW, Inc. reserves the right to incorporate our latest design and material changes without notice or obligation. Design features, materials of construction and dimensional data, as described in this bulletin, are provided for your information only and should not be relied upon unless confirmed in writing.